

TUBULARES

TUBULARES CUADRADOS

SQUARE HOLLOW TUBES

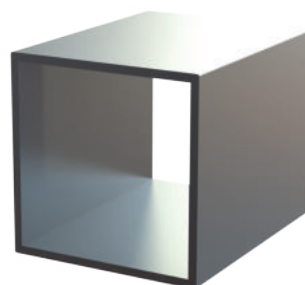

Referencia	Dimensión A		Dimensión B		Perímetro de acabado (mm)
	(mm)	(pulg)	(mm)	(pulg)	
T090	12.7	1/2	1.32	0.052	50.11
T115	19	3/4	0.9	0.035	75.31
T115H	19.05	3/4	2	0.0787	75.31
T116	25	1	0.95	0.037	99.31
T116H	25.4	1	1.2	0.047	101.6
T116H2	25.4	1	1.6	0.063	100.74
T215	38.1	1 1/2	1	0.041	151.71
T215H	38.1	1 1/2	3.1	0.125	151.71
T087	38.1	1 1/2	1.2	0.047	151.71
T070	38.1	1 1/2	1.6	0.063	151.71

TUBULARES REDONDOS

CIRCLE HOLLOW TUBES

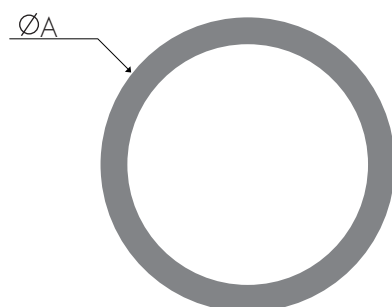

Referencia	Dimensión A		Dimensión B		Perímetro de acabado (mm)
	(mm)	(pulg)	(mm)	(pulg)	
TC001	6.2	1/4	1.425	0.056	19.48
TC004	9.53	3/8	1	0.039	32.89
TC008	12.7	1/2	1.07	0.042	39.89
TC012	15.88	5/8	1.1	0.043	48.89
TC013	19	3/4	1	0.039	59.69
TC021	25.4	1	1.32	0.052	79.79
TC023	25.4	1	1.7	1/16	79.79
TA031	38.1	1 1/2	1	0.039	119.69
T4232	42	1.65	4.75	0.19	131.94
T4331	43	1.69	6	0.24	135.04
T6048	60	2 1/3	5.8	0.23	152.7
TC039	68.8	2.71	2.5	0.098	216.15
T7055	70	2.75	7.5	0.3	219.91
TC040	76.2	3	3	1/8	239.39

*Acabados de nuestros perfiles en pintura electrostática y sublimado, ver colores de referencia en la página 51.

* Finishes of our profiles in electrostatic and sublimated paint, see reference colors on page 51.

TUBULARES RECTANGULARES

RECTANGULAR HOLLOW TUBES

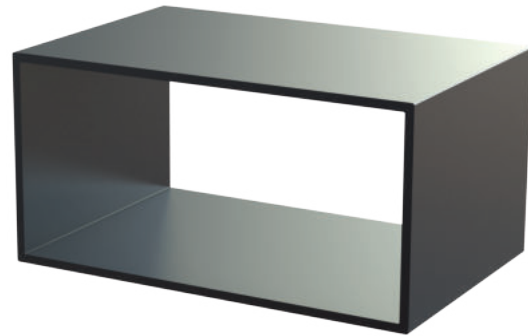
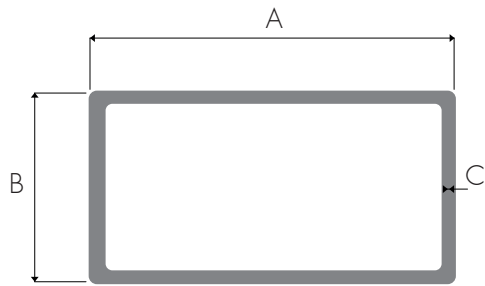

Referencia	Dimensión A		Dimensión B		Dimensión C (mm)	Perímetro de acabado (mm)
	(mm)	(pulg)	(mm)	(pulg)		
TA097	38	1 1/2	19	3/4	1	113.31
T007	50	2	38	1 1/2	1.1	175.14
T007H	50.8	2	38.1	1 1/2	1.9	177.37
T117	50	2	25	1	1.2	149.14
T168	70		19	3/4	0.9	178
T167	70		30		0.9	200
T094	76.2	3	25.4	1	1.17	202.51
T103	76.2	3	38.1	1 1/2	1.11	227.91
T103H	76.2	3	38.1	1 1/2	1.6	227.91
T101	101.6	4	44.45	1 3/4	1.5	291.24
T101H	101.6	4	44.45	1 3/4	1.8	291.24
PHX001	99		40		4	276.28

*Acabados de nuestros perfiles en pintura electrostática y sublimado, ver colores de referencia en la página 51.

* Finishes of our profiles in electrostatic and sublimated paint, see reference colors on page 51.

TUBULARES CON ALETA

TUBULAR WITH FIN

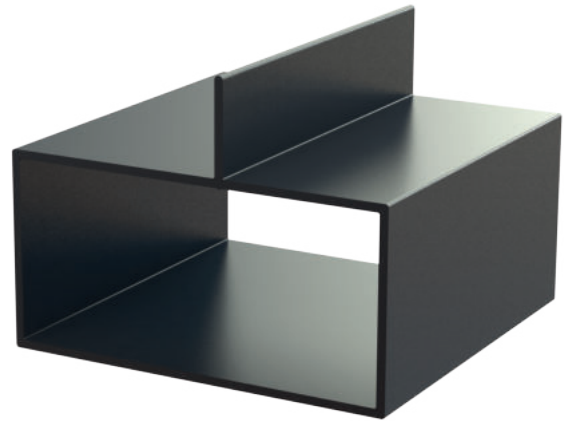
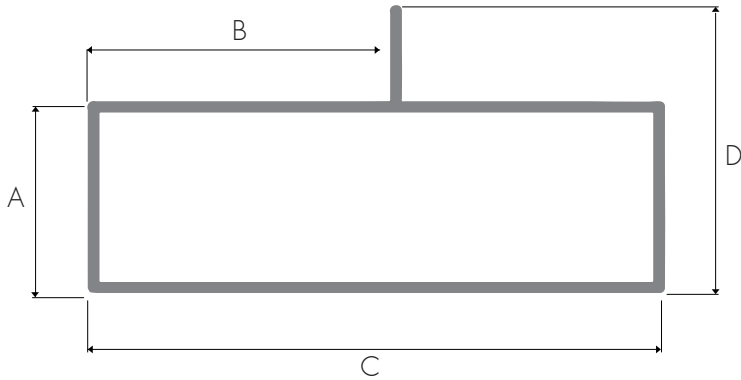

Referencia	Dimensión A		Dimensión B		Dimensión C		Dimensión D		Perímetro de acabado (mm)
	(mm)	(pulg)	(mm)	(pulg)	(mm)	(pulg)	(mm)	(pulg)	
TA037	25	1	28		50	2	37		172.54
TA095	25.4	1	40		76.2	3	38.10	1-1/2	227
T109	25	1	39.9		50	2	37		172.57

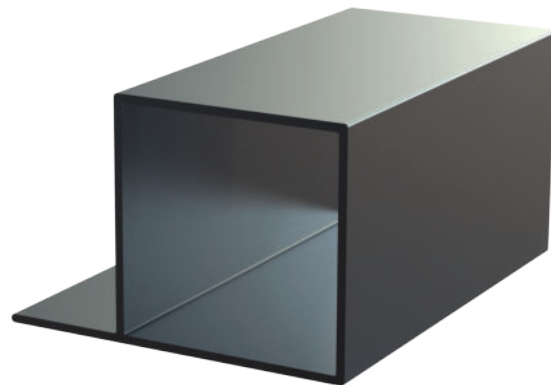
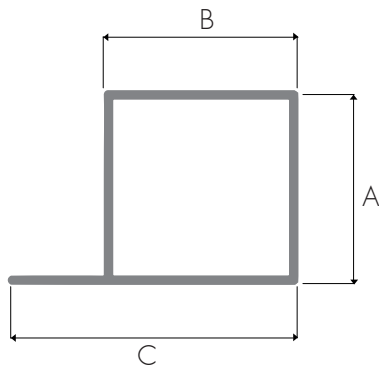

Referencia	Dimensión A		Dimensión B		Dimensión C		Perímetro de acabado (mm)
	(mm)	(pulg)	(mm)	(pulg)	(mm)	(pulg)	
TA077	25.4	1	25.4	1	38	1 1/2	126.1
TA098	18.2		15		27		89.41

TUBULARES CON DOBLE ALETA

TUBULAR WITH DOUBLE FIN

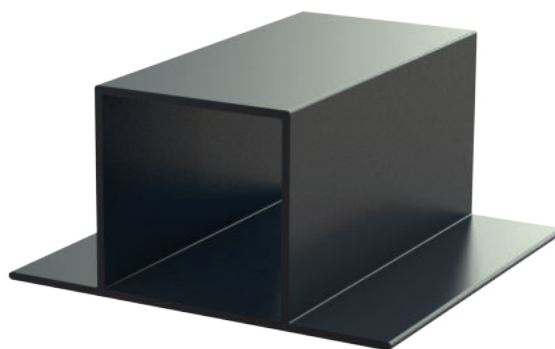
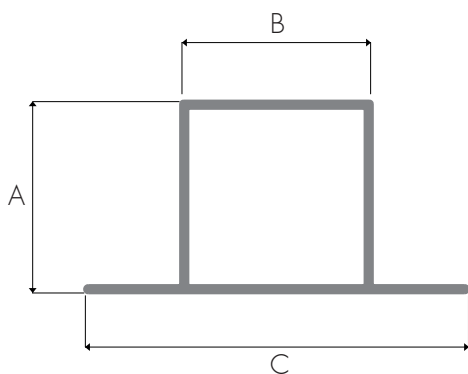

Referencia	Dimensión A		Dimensión B		Dimensión C		Perímetro de acabado (mm)
	(mm)	(pulg)	(mm)	(pulg)	(mm)	(pulg)	
TA078	25.4	1	25.4	1	50.8	2	151.11
TA099	18.2		15		39		112.89

- **TA096** Perímetro de acabado (mm): 254
Finishing perimeter

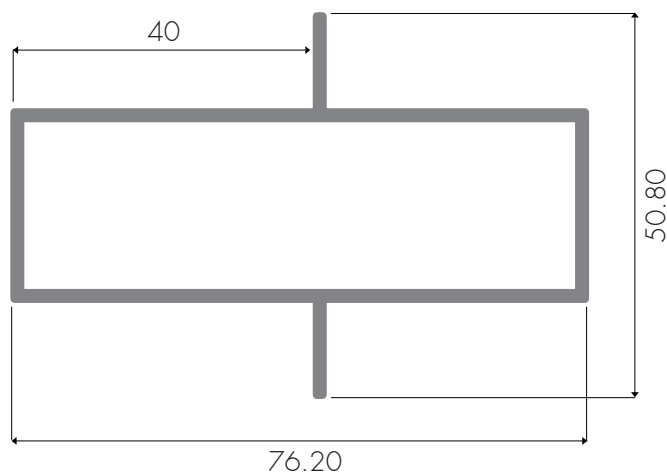

CUARTOS DE CIRCULO

QUARTERS OF CIRCLE

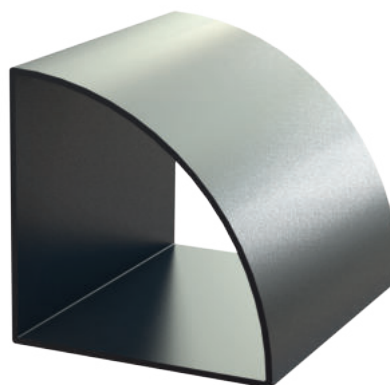
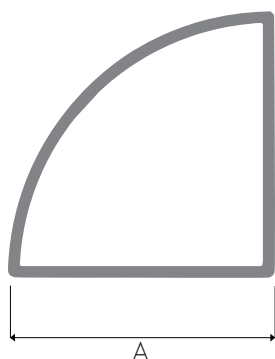

Referencia	Dimensión A		Perímetro de acabado (mm)
	(mm)	(pulg)	
T2382	25.4	1	90.17
T2383	38.1	1 1/2	135.52

T282 Perímetro de acabado (mm): 120.9
Finishing perimeter

Cuarto de circulo de 1" con aleta

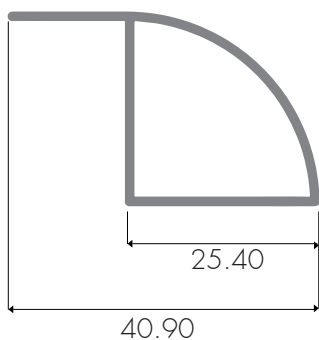

T281 Perímetro de acabado (mm): 151.63
Finishing perimeter

Cuarto de circulo de 1" con doble aleta

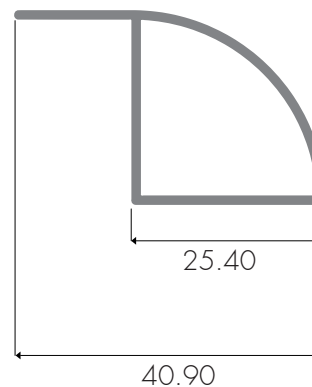

*Acabados de nuestros perfiles en pintura electrostática y sublimado, ver colores de referencia en la página 51.
* Finishes of our profiles in electrostatic and sublimated paint, see reference colors on page 51.