

PERFILES PARA TRANSPORTE Y ESTRUCTURAS

PISO PARA TRAFICO PESADO

FLOOR FOR HEAVY TRAFFIC

- **TRA002** Perímetro de acabado (mm): 207,12
Finishing perimeter

Perfil de inicio

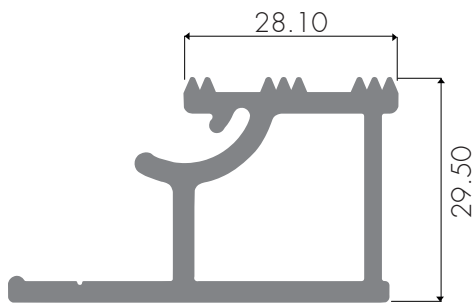

- **TRA003** Perímetro de acabado (mm): 488,86
Finishing perimeter

Perfil principal de remate

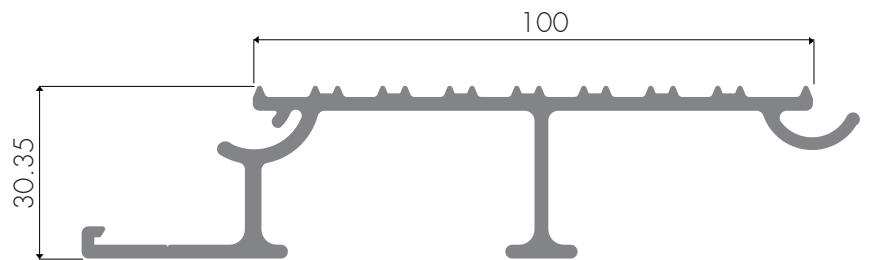

* Acabados de nuestros perfiles en pintura electrostática y sublimado, ver colores de referencia en la página 51.
* Finishes of our profiles in electrostatic and sublimated paint, see reference colors on page 51.

● TRA004 Perímetro de acabado (mm): 223.69
Finishing perimeter

Perfil remate estructural

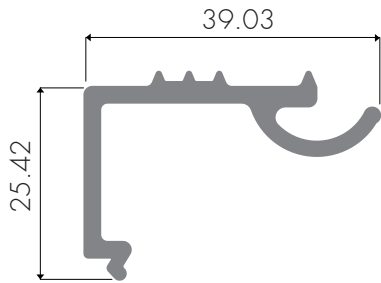

● TRA005 Perímetro de acabado (mm): 223.69
Finishing perimeter

Perfil inicio reparaciones

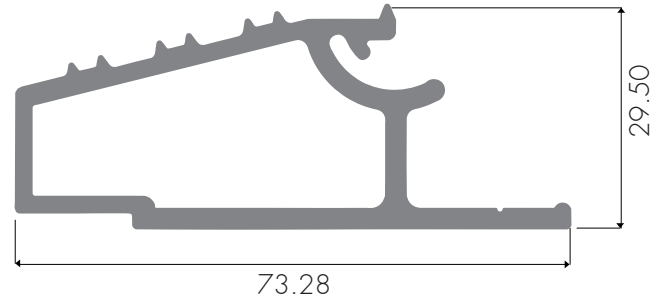

● TRA006 Perímetro de acabado (mm): 469,05
Finishing perimeter

Perfil principal tráfico pesado

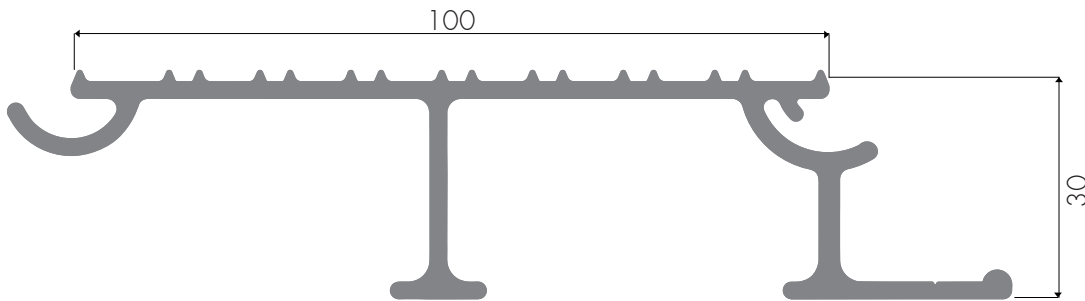

● TRA007 Perímetro de acabado (mm): 166,02
Finishing perimeter

Perfil de remate

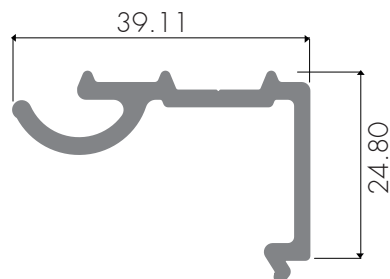

PERFILES PARA FURGÓN

TRUCK PROFILES

ALU033 Perímetro de acabado (mm): 365,49
Finishing perimeter

Piso

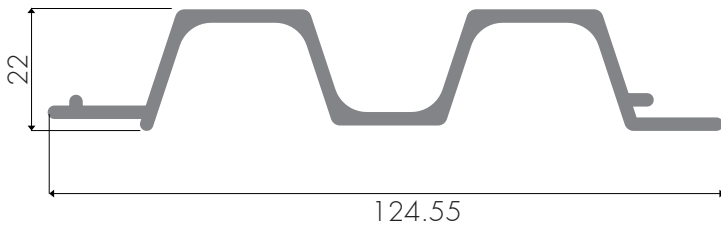

ALC001 Perímetro de acabado (mm): 557.81
Finishing perimeter

Piso

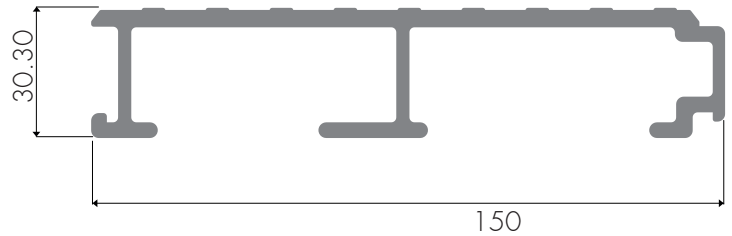

ALU021 Perímetro de acabado (mm): 294.61
Finishing perimeter

Piso

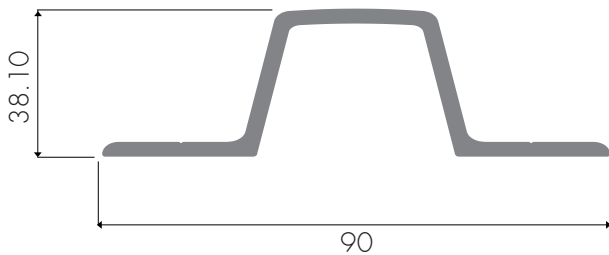

ALC003 Perímetro de acabado (mm): 247.28
Finishing perimeter

Baranda

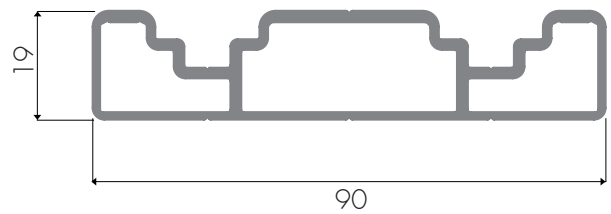

ALU019 Perímetro de acabado (mm): 205.96
Finishing perimeter

Paral vigueta techo

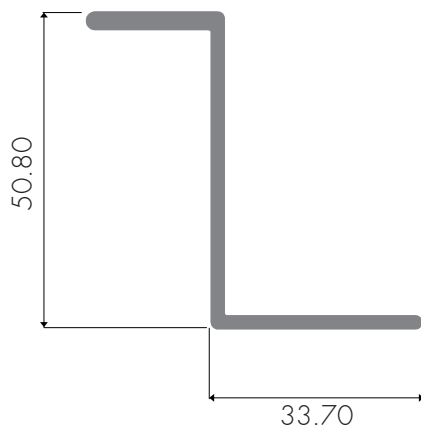

ALC002 Perímetro de acabado (mm): 557.81
Finishing perimeter

Esquinero

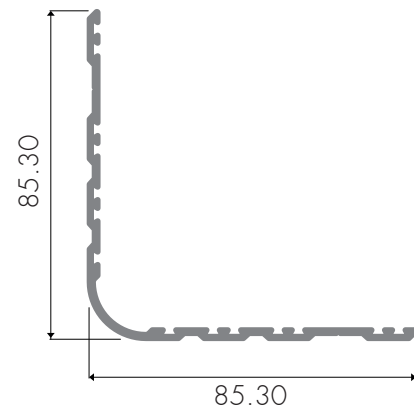

- **ALU022** Perímetro de acabado (mm): 525.69
Finishing perimeter

Riel techo

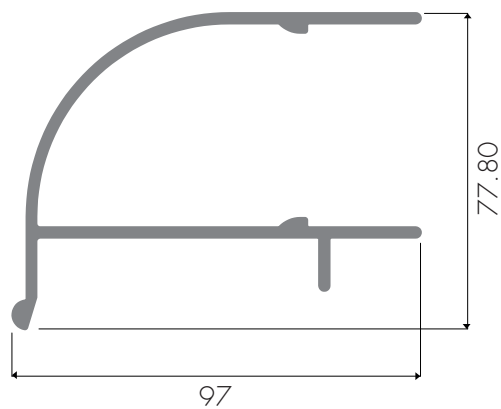

- **ALU028** Perímetro de acabado (mm): 633.96
Finishing perimeter

Esquinero posterior

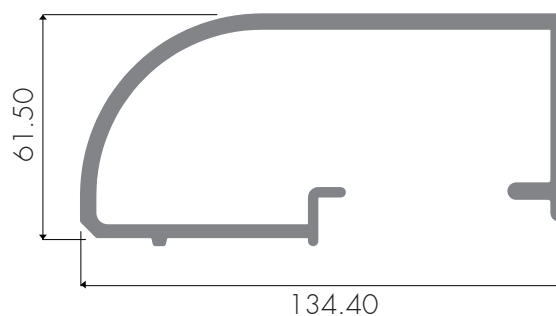

- **ALU034** Perímetro de acabado (mm): 287.92
Finishing perimeter

Puente carrocería

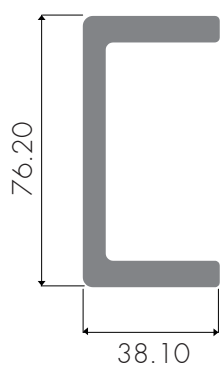

- **ALU041** Perímetro de acabado (mm): 535.93
Finishing perimeter

Larguero

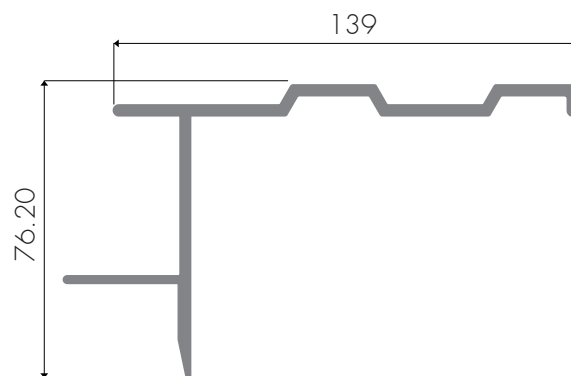

*Acabados de nuestros perfiles en pintura electrostática y sublimado, ver colores de referencia en la página 51.
* Finishes of our profiles in electrostatic and sublimated paint, see reference colors on page 51.